

13

# Symmetry

by

L. S. Dent Glasser

INTERNATIONAL UNION  
OF CRYSTALLOGRAPHY

**This electronic edition may be freely copied and redistributed for educational or research purposes only.**

It may not be sold for profit nor incorporated in any product sold for profit without the express permission of The Executive Secretary, International Union of Crystallography, 2 Abbey Square, Chester CH1 2HU, UK

Copyright in this electronic edition ©2001 International Union of Crystallography



Published for the  
International Union of Crystallography  
by  
University College Cardiff Press  
Cardiff, Wales

© 1984 by the International Union of Crystallography.  
All rights reserved.

Published by the University College Cardiff Press for the  
International Union of Crystallography with the  
financial assistance of Unesco Contract No. SC/RP 250.271

This pamphlet is one of a series prepared by the  
Commission on Crystallographic Teaching of the  
International Union of Crystallography, under the  
General Editorship of Professor C. A. Taylor.  
Copies of this pamphlet and other pamphlets in  
the series may be ordered direct from the  
University College Cardiff Press,  
P.O. Box 78, Cardiff  
CF1 1XL, U.K.

ISBN 0 906449 17 0

Printed by J. W. Arrowsmith Ltd., Bristol

## Series Preface

The long-term aim of the Commission on Crystallographic Teaching in establishing this pamphlet programme is to produce a large collection of short statements each dealing with a specific topic at a specific level. The emphasis is on a particular teaching approach and there may well, in time, be pamphlets giving alternative teaching approaches to the same topic. It is not the function of the Commission to decide on the 'best' approach but to make all available so that teachers can make their own selection. Similarly, in due course, we hope that the same topics will be covered at more than one level.

The first set of ten pamphlets, published in 1981, and this second set of nine represent a sample of the various levels and approaches and it is hoped that they will stimulate many more people to contribute to this scheme. It does not take very long to write a short pamphlet, but its value to someone teaching a topic for the first time can be very great.

Each pamphlet is prefaced by a statement of aims, level, necessary background, etc.

C. A. Taylor  
Editor for the Commission

# Teaching Aims

To convey in non-mathematical language, elementary concepts of symmetry in finite objects and repetitive patterns.

## Level

This material would be suitable as an introduction for undergraduates with no previous knowledge of crystallography.

## Background

General scientific knowledge combined with an interest in learning crystallography.

## Practical Resources

Use is made of Volume I of International Tables for Crystallography (The specific examples used are from the 1965 edition).

## Time Required for Teaching

This represents an introductory course of perhaps two lectures, plus time for the students to study and assimilate the material presented.

# Symmetry

L. S. Dent Glasser

INTERNATIONAL UNION  
OF CRYSTALLOGRAPHY

## 1. Simple Symmetry Operations

The general idea of symmetry is familiar to almost everyone. Formally it can be defined in various ways. The Concise Oxford Dictionary says '1. (Beauty resulting from) right proportion between the parts of the body or any whole, balance, harmony, keeping. 2. Such structure as allows of an object's being divided by a point or line or plane or radiating lines or planes into two or more parts exactly similar in size and shape and in position relative to the dividing point, etc., repetition of exactly similar parts facing each other or a centre, ...'.

The second of the definitions is the one that relates most closely to crystallography and thus concerns us here, but I have also included the first

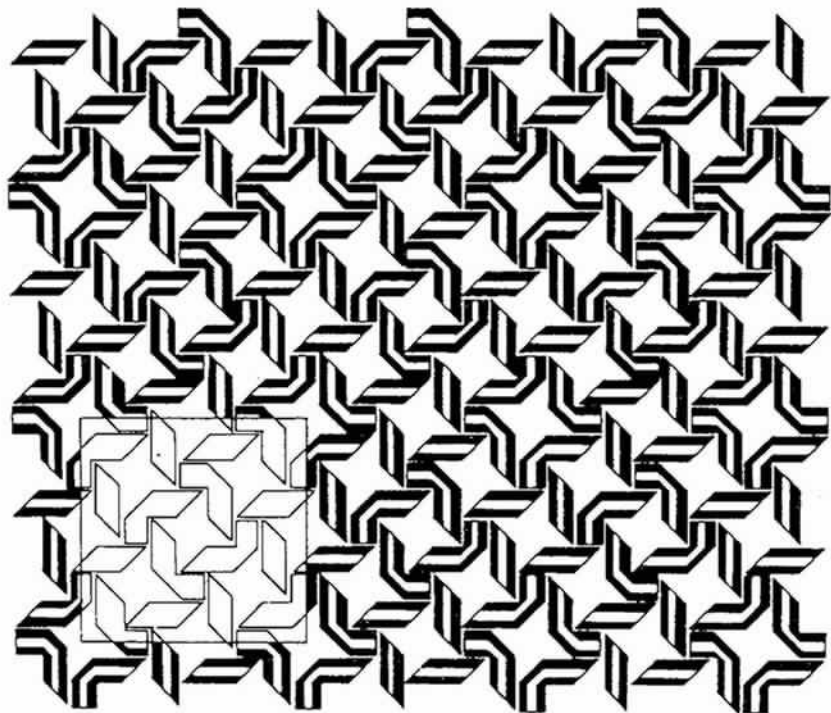

Fig. 1.1. Pattern based on a fourteenth-century Persian tiling design.

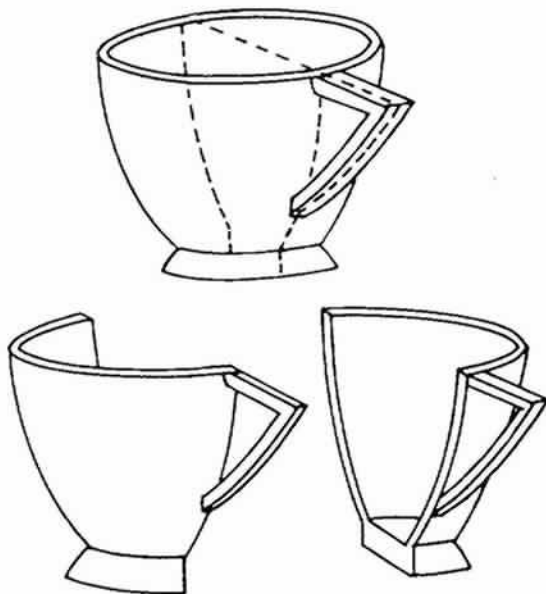

Fig. 1.2. A teacup, showing its mirror plane of symmetry. (After L. S. Dent Glasser, *Crystallography & its applications*: Van Nostrand Reinhold, 1977.)

because it seems to me to express just why the subject is both satisfying and enjoyable. Symmetry and art go hand in hand, as in Fig. 1.1. However, the symmetry of Fig. 1.1 is much more complicated than appears on first sight, so we will begin by considering something rather simpler.

A teacup will do for a start (Fig. 1.2). This is an example of an object that can be divided into two parts by a plane. Since the two parts are mirror images of one another, this symmetry element is called a *mirror plane*. Operation of this element on one half of the teacup generates the other: if a half teacup is held with its sliced edge against a mirror, the appearance of the whole is regenerated. Teacups are rarely sliced in real life (although it was done in the cartoon version of 'Alice in Wonderland'), but you could try it out with an apple or a pear. If the two similar parts produced have no symmetry remaining, as in the case of the teacup, they are called *asymmetric units*.

Biological objects such as flowers frequently show symmetry. The person—hereafter referred to as 'it'\*—shown in Fig. 1.3a also has a mirror plane, provided it stands straight and parts its hair in the middle (and that we ignore its internal organs). Each half of the figure is an asymmetric unit. Moving an arm or leg destroys the symmetry and the whole figure can then be treated as an asymmetric unit. We will use this little person, both with

\* Thus avoiding any sexist implications!

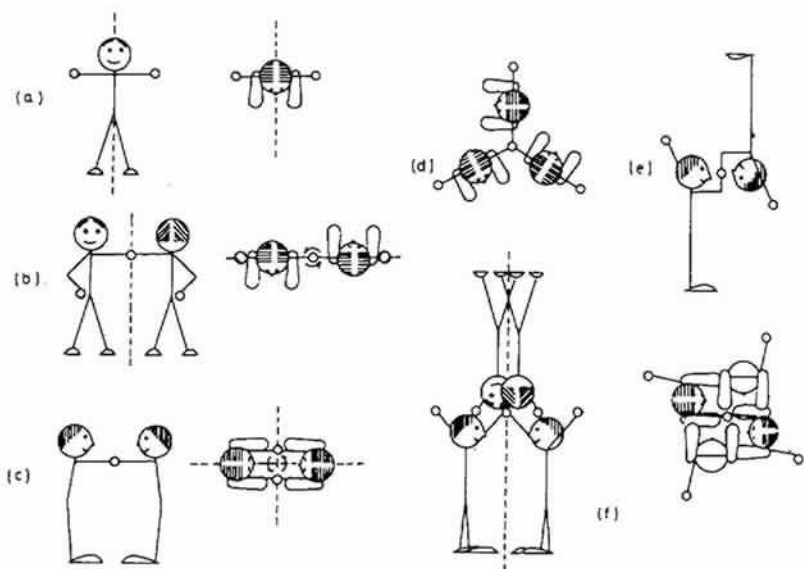

Fig. 1.3. Some symmetry elements, represented by human figures. (a) Mirror plane, shown as dashed line, in elevation and plan. (b) Two-fold axis, lying along broken line in elevation, passing perpendicularly through clasped hands in plan. (c) Combination of two-fold axis with mirror planes; the position of the symmetry elements given only in plan. (d) Three-fold axis, shown in plan only. (e) Centre of symmetry (in centre of clasped hands). (f) Four-fold inversion axis, in elevation and plan, running along the dashed line and through the centre of the clasped hands. (After L. S. Dent Glasser, Chapter 19, *The Chemistry of Cements*: Academic Press, 1964.)

and without its mirror plane, to illustrate further symmetry elements, and to build more complicated groups.

If the figure holds hands with its identical twin, as in Fig. 1.3b, the group formed no longer has a mirror plane. On the other hand rotating the group through  $180^\circ$  about an axis (indicated in the diagram) brings each figure into coincidence with its twin. This group has an *axis of rotation*, two-fold in this case because the operation has to be performed twice before each figure returns to its original position. Figure 1.3c shows how a different method of holding hands produces a group that combines mirror planes with a two-fold axis; in Fig. 1.3d identical triplets demonstrate a three-fold axis. (Can you identify a four-fold axis in Fig. 1.1? Does it have any two-fold axes or mirror symmetry?).

Isolated objects or groups of objects may show any number of mirror planes and any kind of axis; the symmetry of an infinite array of identical groups, such as is found in a crystal, is limited by having to pack the units together in three dimensions. This limitation means that in crystallography only centres of symmetry (Fig. 1.3e), mirror planes, two-, three-, four- and six-fold and the corresponding inversion axes are encountered. An inversion

axis involves rotation plus inversion through a point; Fig. 1.3f represents a four-fold inversion axis, rotation through one fourth of a revolution being followed by inversion through a point in the middle of the clasped hands. A one-fold inversion axis is equivalent to a centre of symmetry (Fig. 1.3e) and a two-fold inversion axis to a mirror plane. (This last equivalence is important in other contexts because it established a mirror plane as a two-fold symmetry operator).

It is not very convenient to illustrate symmetry elements in the way that we have just used: rather than drawing little people we use circles to represent asymmetric units: conventionally an open circle represents a right-handed unit and a circle with a comma in it its mirror image or *enantiomorph* (i.e. a left-handed unit). Figure 1.4 shows the same groups as Fig. 1.3, represented in this formal, shorthand way.

Even this is inconvenient in written text, in which mirror planes are given the symbol  $m$ , while axes and the corresponding inversion axes are referred to as 1,  $\bar{1}$ ; 2,  $\bar{2}$  ( $\equiv m$ ); 3,  $\bar{3}$ ; 4,  $\bar{4}$ ; 6,  $\bar{6}$ . The symbol 1 (for a one-fold axis) means no symmetry at all, while the corresponding inversion axis ( $\bar{1}$ ) is equivalent, as already remarked, to a centre of symmetry.

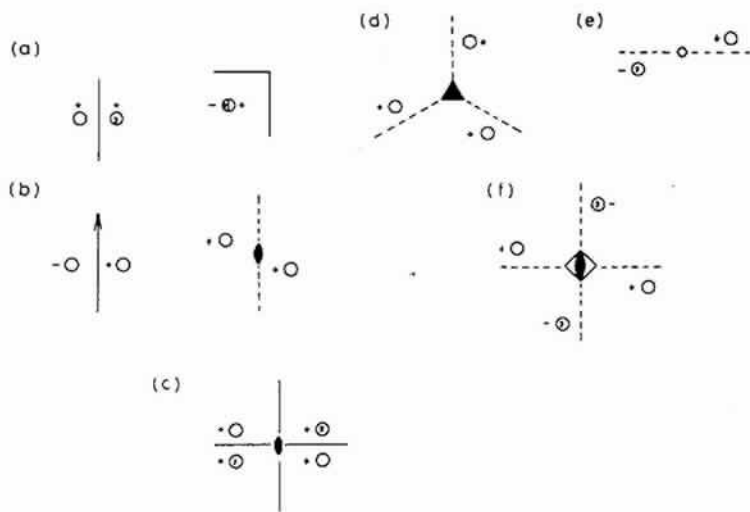

Fig. 1.4. The arrangements in figure 1.3 redrawn using conventional symbols. The right-hand group of (a) is drawn here in a different orientation, and the left-hand groups of (c) and (f) are omitted. Symbols + and - represent equal distances above and below the plane of the paper; open circles represent asymmetric units of one hand, and circles with commas their enantiomorphs. (a) Mirror plane ( $m$ ), perpendicular to (left) and in the plane of the paper. (b) Two-fold axis (2) in the plane of the paper (left) and perpendicular to it (right). (c) Combination of two-fold axes and mirror planes. Note that the presence of any two of these elements creates the third. (d) Three-fold axis (3). (e) Centre of symmetry ( $\bar{1}$ ). (f) Four-fold inversion axis ( $\bar{4}$ ).



## 2. Combination of Symmetry Elements in Finite Groups

The complete symmetry displayed by an isolated object or group of objects is its *point group*, there being always at least one point common to all the symmetry elements. We have already met such a collection of symmetry elements in Figs. 1.3c and 1.4c, comprising two mirror planes intersecting in a two-fold axis. Note that no single one of these elements can be left out of the group, because the presence of any two creates the third. This being so, two of the elements are sufficient to define the whole, and this particular point group is normally given the short symbol  $mm$ , rather than the full symbol  $2mm$  or  $mm2$ .

Similarly, three mirror planes meeting in a three-fold axis (Fig. 2.1a) are adequately represented by  $3m$ . The full symbol  $3mmm$  is not needed because two of the 'm's are redundant, being created by the action of the three-fold axis on the other one. Figure 2.1b shows a mirror plane perpendicular to a two-fold rotation axis; this is given the symbol  $2/m$ , the '/' implying 'perpendicular to'. (Note that the combination produces a centre of symmetry at the point where the rotation axis intersects the mirror plane).

This system of nomenclature, which is the one most often used in crystallography is largely self-explanatory, and with very little practice one can

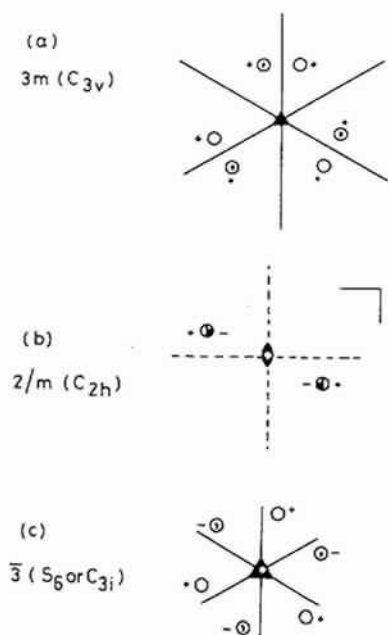

Fig. 2.1. Some combinations of symmetry elements with their point-group symbols. The equivalent Schoenflies symbol is given in brackets.

draw the appropriate collection of symmetry elements and asymmetric units for any symbol. There is also an older system in use which is not so convenient for our purposes; in Fig. 2.1 examples of this *Schoenflies* notation are given in brackets after the crystallographic (*Hermann-Mauguin*) notation: a concordance between the two is given in Table 1. A major difference is that the operator that we have called an inversion axis  $\bar{n}$  (=  $n$ -fold rotation plus inversion through a point) is replaced by an alternating axis  $S_n$  (= rotation plus reflection across a plane) in the Schoenflies notation. Moreover, as Fig. 2.1c shows,  $n$  may change: a three-fold inversion axis corresponds to a six-fold alternating axis. Inconvenient though this may be, it does illustrate that the distinction between three- and six-fold symmetry is sometimes a matter of definition, and therefore arbitrary.

There are thirty-two distinct combinations of the crystallographic symmetry operations that relate to finite groups, and thus there are thirty-two point groups or *crystal classes*; crystals often reveal the class to which they belong through the symmetry of their external forms. These crystal classes are conveniently grouped into systems according to the restrictions placed on the shape of the unit cell (see next section) by the symmetry of its contents. This is summarised in Table 1.

### 3. Symmetry Elements in Arrays

If you look back at Fig. 1.1, you will see that it combines elements of symmetry with a repeating pattern. We call such a repeating pattern of motifs an *array*; the smallest convenient parallelogram that can be repeated without change of orientation to produce the pattern is called the *unit cell*. A two-dimensional unit cell is outlined in Fig. 1.1; note that while the choice of origin is somewhat arbitrary the shape is not. (Check this by identifying other ways of defining the repeating unit.)

In a three-dimensional array, such as a crystal, the unit cell is a parallelepiped defined by intercepts  $a$ ,  $b$ ,  $c$  on three axes ( $x$ ,  $y$ ,  $z$ ) and the angles between them,  $\alpha$ ,  $\beta$ ,  $\gamma$ , as shown in Fig. 3.1. If the contents have no symmetry or a centre of symmetry only, the unit cell can have this quite general shape; more symmetrical cell contents restrict the values of the interaxial angles and the relative sizes of the edges in the manner given in Table 1. Thus a single direction of two-fold symmetry (monoclinic system) makes two of the angles into right-angles but places no restrictions on the third or on the edge dimensions; at the other extreme, cubic symmetry produces a cell whose edges are all equal and whose angles are all  $90^\circ$  (i.e. a cube!).

An array can have any of the symmetry elements that we have discussed already, including no symmetry at all (Fig. 3.2), and it can also have additional types of symmetry not possible in finite objects. Consider Fig.

Table 1. Crystal systems and classes (equivalent Schoenflies nomenclature for the latter in brackets)

System	Characteristic symmetry	Unit cell shape	Lattice types	Classes
Triclinic	None	$a \neq b \neq c$ $\alpha \neq \beta \neq \gamma \neq 90^\circ$	<i>P</i>	$1(C_1), \bar{1}(C_1, S_2)$
Monoclinic	One two-fold axis (2 or $\bar{2} \equiv m$ )	$a \neq b \neq c$ $\alpha = \gamma = 90^\circ \neq \beta$	<i>P, C</i> (or <i>A</i> )	$2(C_2), m(\bar{2})(C_2)$ $2/m(C_{2h})$
Orthorhombic	Three mutually perpendicular two-fold axes	$a \neq b \neq c$ $\alpha = \beta = \gamma = 90^\circ$	<i>P, C,</i> (or <i>A</i> or <i>B</i> )	$222(D_2), mm2(C_{2v})$ $mmm(D_{2h})$
Tetragonal	One four-fold axis	$a = b \neq c$ $\alpha = \beta = \gamma = 90^\circ$	<i>P, I</i>	$4(C_4), \bar{4}(S_8), 4/m(C_{4h}),$ $422(D_4), 4mm(C_{4v})$ $42m(D_{2d}), 4/mmm(D_{4h})$
Trigonal	One three-fold axis	$a = b \neq c$ $\alpha = \beta = 90^\circ$	<i>P, R</i>	$3(C_3), \bar{3}(S_6, C_{3i}), 32(D_3)$ $3m(C_{3v}), 3m(D_{3d})$
Hexagonal	One six-fold axis	$\gamma = 120^\circ$ $a = b \neq c$ $\alpha = \beta = 90^\circ$	<i>P</i>	$6(C_6), \bar{6}(C_{3h}), 6/m(C_{6h}),$ $622(D_6), 6mm(C_{6v}), \bar{6}m2(D_{3h})$ $6/mmm(D_{6h})$
Cubic	Four three-fold axes (along body diagonals of a cube)	$\alpha = \beta = \gamma = 90^\circ$ $a = b = c$	<i>P, I, F</i>	$23(T), m\bar{3}(T_h), 432(O)$ $43m(T_d), m3m(O_h)$

$\neq$  Not necessarily equal to.

\* That is, no restrictions.

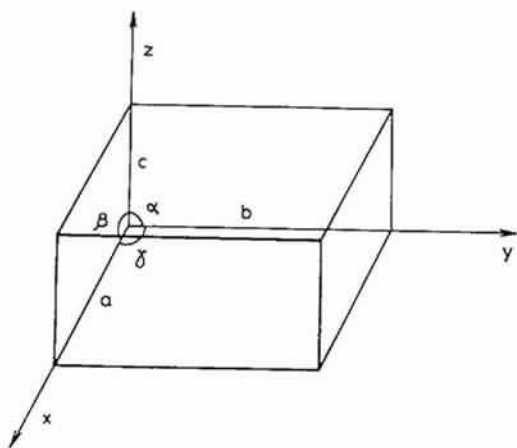

Fig. 3.1. A generalised unit cell, showing the repeat distances  $a$ ,  $b$ ,  $c$  along the  $x$ ,  $y$ , and  $z$  axes, and the interaxial angles  $\alpha$ ,  $\beta$  and  $\gamma$ .

3.3, which shows an aerial view of a boat rowed by eight crew; provided that they have been well-coached they present a symmetrical appearance, but it is not one that can be exactly described by any of the symmetry elements introduced so far. It is obviously related to a mirror plane, but in Fig. 3.3 each rower is the mirror image of one rowing immediately in front or behind. Any figure is related to the next by moving one place along the boat and then reflecting across a mirror plane. A symmetry operation of this type is called—very descriptively—a *glide plane*. Because a glide plane combines the operation of reflection with that of translation it occurs only in extended arrays.

An analogous operation combining rotation and translation is called—equally descriptively—a *screw axis*. As an actual example of an object possessing this type of symmetry, a bolt is really better than a screw, since most screws taper to a point, but the action of driving a screw—or using a

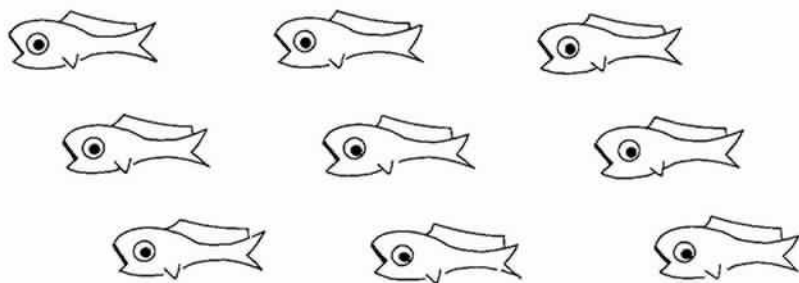

Fig. 3.2 An array of repeating motifs: neither the motif nor the array contains any elements of symmetry.

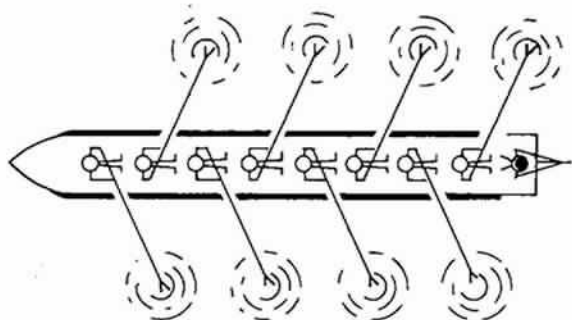

Fig. 3.3. A stylised aerial view of a well-coached 'eight', showing a translational symmetry operation: each rower is related to the next by a combination of translation and reflection.

corkscrew!—illustrates very vividly the operation of a screw axis. Other familiar objects having screw axes are spiral staircases, springs, and some climbing plants. Formal examples are shown in Fig. 3.4, together with a formal representation of a glide plane.

The general symbol for a screw axis is  $N_n$ , where  $N$  is the order (2, 3, 4 or 6) of the axis, and  $n/N$  the translation distance expressed as a fraction

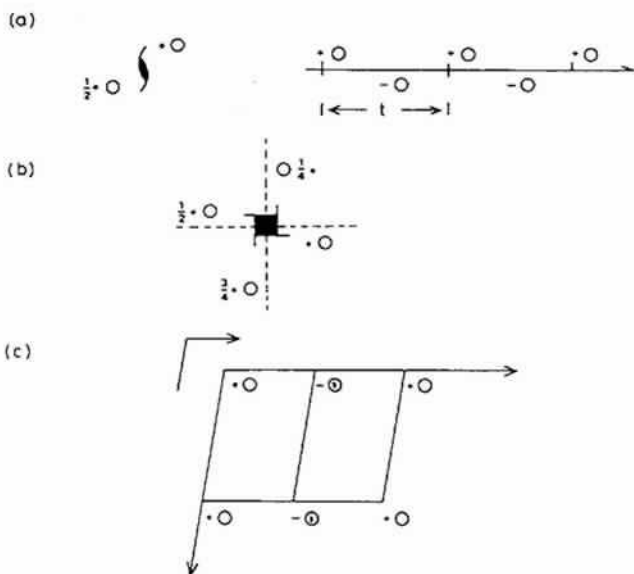

Fig. 3.4. Translational symmetry elements. (a) A two-fold screw axis,  $2_1$ , shown perpendicular to the plane of the paper (left) and in the plane of the paper (right). Each half revolution is accompanied by a translation through half the repeat distance. (b) A four-fold screw axis,  $4_1$ . (c) A glide plane. Translation from left to right across the page is accompanied by reflection through the plane of the paper.

of the repeat unit. Thus  $4_1$ , shown in Fig. 3.4b, means that the asymmetric unit moves  $\frac{1}{4}$  of a repeat unit along the axis for each  $\frac{1}{4}$  of a revolution about that axis. Glide planes are symbolised by a letter indicating the direction of the glide: the letters  $a$ ,  $b$  and  $c$  mean that the direction of glide is parallel to the  $a$ ,  $b$  and  $c$  axes respectively, while  $n$  and  $d$  refer to glide planes in which the direction of glide is diagonally across a face of the unit cell or along a body diagonal.

A combination of parallel translational and non-translational symmetry elements produces an interesting effect on the way in which the pattern repeats. Consider Fig. 3.5. The pattern in 3.5a contains mirror planes: note that two mirror planes are associated with each repeat unit across the page. The pattern in 3.5b is based on a similar motif related by glide planes ( $g$ ); again two are associated with each repeat unit across the page. In 3.5c there are parallel mirror and glide planes, and as a result the grouping of motifs

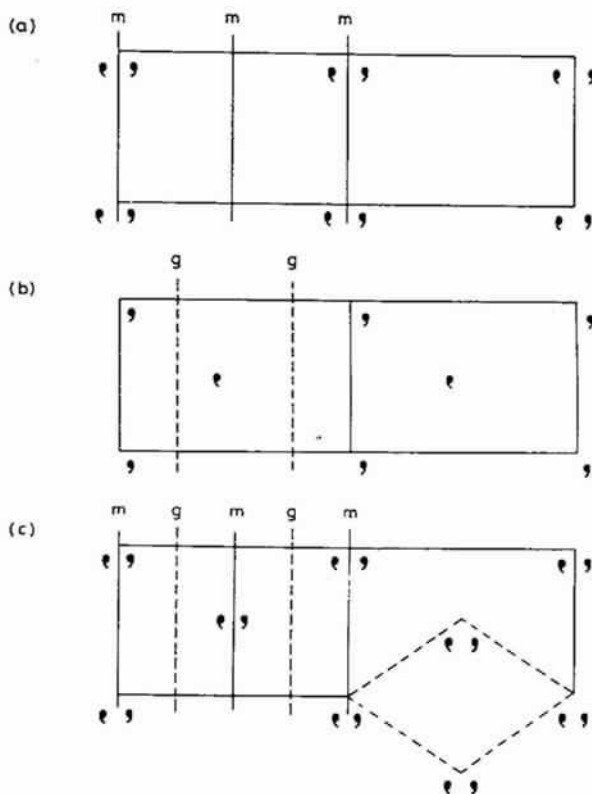

Fig. 3.5. Non-translational and translational symmetry elements and their combination. (a) mirror planes. (b) glide planes. (c) parallel mirror and glide planes, producing a centred pattern. The dashed lines outline a possible (but inconvenient) primitive cell.

at the centre of the rectangular cell is identical with that at the corners. Such a pattern is called *centred*, while those of 3.5a and 3.5b are said to be *primitive*. It is always possible to define a smaller primitive cell for a centred pattern, such as the diamond-shaped cell outlined at the lower right of 3.5c. However, this is not normally done, partly because such a cell is a less convenient shape, but more importantly because its axes no longer bear the correct relationship to the symmetry elements of the pattern.

#### 4. Space Groups

Just as the non-translational symmetry elements can be combined into point group symbols that describe the symmetry of finite groups, so the symmetry of infinite arrays can be summarized and symbolized. The addition of translation greatly increases the possibilities, so that instead of the 32 point groups 230 *space groups* are needed to describe the symmetries of infinite arrays. A complete list of these, with descriptions, is given in International Tables for X-Ray Crystallography (see Section 5). All that will be attempted here is to try to give some idea of what a space group symbol means and how to interpret it.

Typical space group symbols are:  $P\bar{1}$ ,  $C2/m$ ,  $Ibca$ ,  $R\bar{3}$ ,  $Fm\bar{3}m$ ,  $P2_12_12_1$ . You will notice that they all begin with a capital letter. This gives the *lattice type*, which tells you whether the unit cell is primitive or centred. *P* means primitive, *A*, *B*, or *C* means centred on the face perpendicular to the *a*, *b* or *c* axis respectively, *F* means centred on all the faces, *I* means body-centred—centred in the middle of the cell (from the German, *innenzentriert*)—and *R* means rhombohedral, which is a special type of centring unique to the trigonal system. The group of symbols that follow give you the crystal class, and hence the system. Thus in  $P\bar{1}$ , the symbol  $\bar{1}$  tells you that the system is triclinic (see Table 1). Likewise  $C2/m$  belongs to class  $2/m$ , which you can see from Table 1 is monoclinic.  $R\bar{3}$  and  $Fm\bar{3}m$  are equally easy to assign to the trigonal and cubic systems respectively.  $Ibca$  presents slightly more of a problem; the symbols *b*, *c* and *a* refer to glide planes, as explained in the previous section. To find the crystal class, simply replace any translational symmetry element by the equivalent non-translational element: this rule holds for both glide planes and screw axes. Thus  $Ibca$  belongs to class  $mmm$ , and is orthorhombic; the last example,  $P2_12_12_1$ , belongs to class 222 and is also orthorhombic. The symbol also gives the positions of the various symmetry elements. Just as  $mmm$  implies mirror planes perpendicular to the three mutually perpendicular axes of the orthorhombic system, so  $Ibca$  tells us that in the body-centred array there are *b* glide planes perpendicular to the *x*-axis, *c* glides perpendicular to *y* and *a* glides perpendicular to *z*.

The page of International Tables describing  $Pnma$  is reproduced in Fig. 5.1, from which it can be seen that the *total* collection of symmetry elements

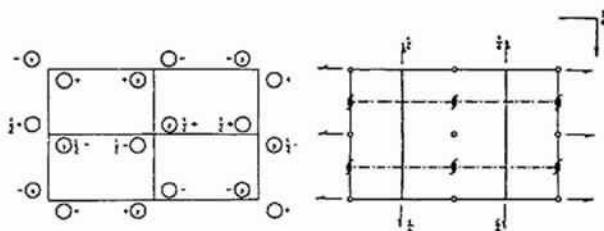
Origin at  $\bar{1}$ Number of positions,  
Wyckoff notation,  
and point symmetry

Co-ordinates of equivalent positions

Conditions limiting  
possible reflections

8	$d$	1	$x, y, z;$	$\frac{1}{2} + x, \frac{1}{2} - y, \frac{1}{2} - z;$	$\bar{x}, \frac{1}{2} + y, \bar{z};$	$\frac{1}{2} - x, \frac{1}{2}, \frac{1}{2} + z;$
			$\bar{x}, \bar{y}, \bar{z};$	$\frac{1}{2} - x, \frac{1}{2} + y, \frac{1}{2} + z;$	$x, \frac{1}{2} - y, x;$	$\frac{1}{2} + x, y, \frac{1}{2} - z.$

General:

$hkl$ :	No conditions
$0kl$ :	$k+l=2n$
$h0l$ :	No conditions
$hk0$ :	$h=2n$
$h00$ :	$(h=2n)$
$0k0$ :	$(k=2n)$
$00l$ :	$(l=2n)$

4	$c$	$m$	$x, \frac{1}{2}, z;$	$\bar{x}, \frac{1}{2}, \bar{z};$	$\frac{1}{2} - x, \frac{1}{2}, \frac{1}{2} + z;$	$\frac{1}{2} + x, \frac{1}{2}, \frac{1}{2} - z.$
4	$b$	$\bar{1}$	$0, 0, \frac{1}{2};$	$0, \frac{1}{2}, \frac{1}{2};$	$\frac{1}{2}, 0, 0;$	$\frac{1}{2}, \frac{1}{2}, 0.$
4	$a$	$\bar{1}$	$0, 0, 0;$	$0, \frac{1}{2}, 0;$	$\frac{1}{2}, 0, \frac{1}{2};$	$\frac{1}{2}, \frac{1}{2}, \frac{1}{2}.$

Special: as above, plus  
no extra conditions

$hkl$ :	$h+l=2n;$	$k=2n$
---------	-----------	--------

Symmetry of special projections

 $(001) pgm; a' = a/2, b' = b$  $(100) cmn; b' = b, c' = c$  $(010) pgg; c' = c, a' = a$ 

Fig. 5.1. Page 151, Vol. 1, reproduced from *International Tables for X-Ray Crystallography*, 1965 edition (by kind permission of the International Union of Crystallography).

includes many that are not listed in the space group symbol. Only the essential elements are given in the symbol; redundant ones are omitted, just as they are from point group symbols.

## 5. International Tables for X-Ray Crystallography, Volume I

International Tables for X-Ray Crystallography contain a great deal of information concerning various aspects of crystallography, and the first volume deals with symmetry. Among other things, it introduces symmetry considerations in more detail and at a more advanced level than can be given here. It also lists information about all the space groups, and it is this that we will consider now. Figure 5.1 reproduces a typical page from



the space group listings, and we will use it to explain some of the important features.

The space group symbol—*Pnma*—is given in bold type at the top of the page, together with the equivalent Schoenflies symbol. Replacing the translational elements *n* and *a* by the non-translational equivalent *m* gives crystal class *mmm*, system orthorhombic: this information is also given at the top of the page. On this same line are: (1) the full symbol  $P2_1/n2_1/m2_1/a$  (which includes redundant two-fold screw axes parallel to *a*, *b* and *c* created by the interaction of the mirror and glide planes) (2) the space group number, 62. The space groups are listed in a logical sequence in increasing symmetry of their crystal classes, beginning with No. 1, *P1*, which has no symmetry at all, and ending with the highly symmetric cubic group *Ia3d*, No. 230.

Immediately below this top line are two diagrams representing the space group in terms of asymmetric units (on the left) and as a collection of symmetry elements (on the right). They are projected onto the page down the *z*-axis, with the *y*-axis running horizontally from left to right across the page and the *x*-axis downwards. The space group symbol tells us that there is an *n*-glide plane perpendicular to the *x*-axis, a mirror plane perpendicular to the *y*-axis and an *a*-glide plane perpendicular to the *z*-axis (i.e. parallel to the plane of the paper); these appear on the right-hand diagram as

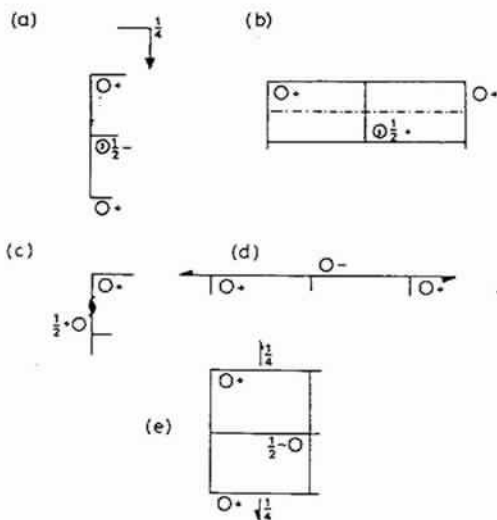

Fig. 5.2. The equivalent groups generated by the operation of some of the symmetry elements in *Pnma*. (a) An *a*-glide plane parallel to the plane of the paper. The group is moved down the diagram by  $a/2$ , and then reflected. (b) An *n*-glide plane perpendicular to *a* moves the same group  $b/2$  to the right and  $c/2$  vertically before reflection. (c), (d), (e) Screw axes move the group through  $a/2$ ,  $b/2$  and  $c/2$  respectively while rotating it through  $180^\circ$ .

dot-dash lines, heavy solid lines, and a right-angled line with an arrow respectively. (The arrow shows the direction of the glide—along  $a$ ; the small figure  $\frac{1}{4}$  indicates that the glide plane is  $c/4$  above the plane of the diagram.) The redundant two-fold screw axes also appear, and a number of centres of symmetry are created.

The effect of these symmetry operations can be traced in the left hand diagram. The effect of the mirror plane is particularly easy to see (refer back to Fig. 1.4). After you have found this, look for the effect of the glide planes and screw axes; a key is given in Fig. 5.2. All the reflection planes occur in groups, separated by half a cell edge; here they are  $\frac{1}{4}$  and  $\frac{3}{4}$  of the way along because the origin has been chosen at a centre of symmetry (this has computational advantages).

The remaining feature of the page that concerns us here is the list of co-ordinates of equivalent positions. An asymmetric group placed at random in the cell (at  $x, y, z$ , for example, a position represented by the open circle at '+' in the top left hand corner of the left hand diagram) must be matched by seven other groups, a total of eight in all. Applied to a crystal structure, this means that an atom that occurs in such a *general position* must be one of a total of eight similar atoms in the unit cell; this can be very helpful in deciding chemical formulae. In the Tables, the coordinates corresponding to this general position are listed first: 8 is the number of equivalent positions,  $d$  is simply a letter assigned as a convenient means of referring to the set, and 1 shows that the site has no symmetry.

Suppose now that the group is moved from  $x, y, z$  to  $x, \frac{1}{2}, z$ —that is, onto the mirror plane (Fig. 5.3). This brings it into coincidence with its mirror image, and reduces the number of groups to four. This situation is summarised in the line beginning  $4c\dots$ ; the symmetry of the site is now  $m$ , and there are only four equivalent positions instead of eight. The remaining two lines show the effect of selecting a position on one or other of the centres of symmetry. We make no use here of the rest of the information on the page.

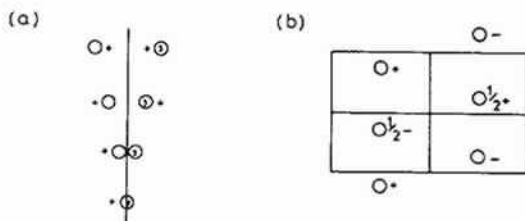

Fig. 5.3. Groups or atoms on special positions. (a) The effect of moving an asymmetric group onto a mirror plane; it no longer produces an equivalent group through the mirror, but must itself now possess a mirror plane of symmetry. (b) If an atom is placed on the special position  $c$  in  $Pnma$  there must be three more similar atoms in the cell, arranged as shown (not seven as in the general case).

This final paragraph gives a very brief illustration of one practical use of such symmetry information. Suppose that a metal sulphate,  $MSO_4$ , crystallizes in this space group with four formula units per cell. The four  $M$  and  $S$  atoms must lie on one of the positions,  $a$ ,  $b$  or  $c$ ; the sulphur atom forms part of a sulphate group.  $SO_4$  groups are tetrahedral, tetrahedra don't have centres of symmetry but *do* have mirror planes: therefore the sulphur atom must occupy position  $c$ , on the mirror planes (as also must two of the oxygen atoms attached to it). Combining this information with a knowledge of bond lengths should enable a trial structure to be worked out.

# International Union of Crystallography Commission on Crystallographic Teaching

## FIRST SERIES PAMPHLETS (1981)

- |  |                               |
|--|-------------------------------|
| 1. A non-mathematical introduction to X-ray diffraction.                       | C. A. Taylor                  |
| 2. An introduction to the scope, potential and applications of X-ray analysis. | M. Laing                      |
| 3. Introduction to the Calculation of Structure Factors.                       | S. C. Wallwork                |
| 4. The Reciprocal Lattice.   | A. Authier                    |
| 5. Close-packed structures.  | P. Krishna and D. Pandey      |
| 6. Pourquoi les groupes de Symetrie en Cristallographie.                       | D. Weigel                     |
| 7. Solving the phase problem when heavy atoms are in special positions.        | L. Hohne and<br>L. Kutchabsky |
| 8. Anomalous Dispersion of X-rays in Crystallography.                          | S. Caticha-Ellis              |
| 9. Rotation Matrices and Translation Vectors in Crystallography.               | S. Hovmöller                  |
| 10. Metric Tensor and Symmetry operations in Crystallography.                  | G. Rigault                    |

## SECOND SERIES PAMPHLETS (1984)

- |   |                                    |
|---|------------------------------------|
| 11. The Stereographic Projection.   | E. J. W. Whittaker                 |
| 12. Projections of Cubic Crystals.  | Ian O. Angell and<br>Moreton Moore |
| 13. Symmetry.   | L. S. Dent Glasser                 |
| 14. Space Group Patterns.   | W. M. Meier                        |
| 15. Elementary X-Ray Diffraction for Biologists.  | Jenny P. Glusker                   |
| 16. The Study of Metals and Alloys by X-ray Powder Diffraction Methods.   | H. Lipson                          |
| 17. An Introduction to Direct Methods. The Most Important Phase Relationships and their Application in Solving the Phase Problem. | H. Schenk                          |
| 18. An Introduction to Crystal Physics.   | Ervin Hartmann                     |
| 19. Introduction to Neutron Powder Diffractometry.  | E. Arzi                            |

This selection of booklets represents a sample of teaching approaches at various levels (undergraduate and postgraduate) and in various styles. The Commission on Crystallographic Teaching of the International Union of Crystallography hopes to develop the series into a large collection from which teachers can make selections appropriate to their needs and has particularly borne in mind the needs of developing countries and of the problem of teaching crystallography to students of other disciplines such as chemistry, biology, etc. and priced as follows: 95p each.

Available from:

University College Cardiff Press P O Box 78 Cardiff CF1 1XL Wales, U.K.

Cheques should be made payable to University College Cardiff.